



TECHNISCHE
UNIVERSITÄT
DRESDEN

Fakultät Mathematik und Naturwissenschaften, FR Psychologie, Institut für Allgemeine Psychologie,
Biopsychologie und Methoden der Psychologie, Professur Neuroimaging

What are we measuring with M/EEG?

Stefan Kiebel

May 11th 2015



DRESDEN
concept
Exzellenz aus
Wissenschaft
und Kultur

Overview

- 1 History
- 2 Genesis of EEG/MEG signal
- 3 Measurement specifics
- 4 Forward models

Overview

1 History

2 Genesis of M/EEG signal

3 Measurement specifics

4 Forward models

EEG History

Hans Berger measured the first EEG on 6th of July 1924.

Director of Psychiatry, Professor in Jena/Germany from 1919 to 1938.

He published his first paper in 1929 only, apparently to achieve certainty about the finding.

His results went mostly unnoticed until 1934 when Edgar Adrian (an English physiologist and nobel price winner of 1932) found Berger's paper (published in German), and sucessfully repeated the experiments (on the alpha rythm from the occipital lobes).

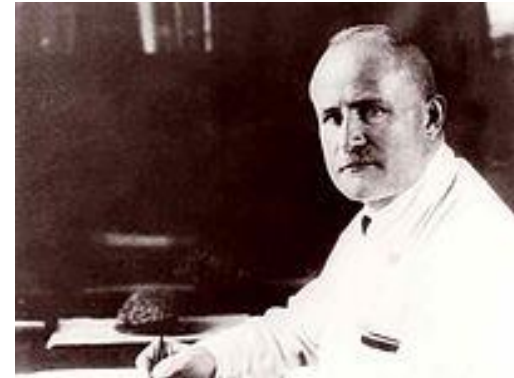

Hans Berger, 1873 – 1941
(wiki)

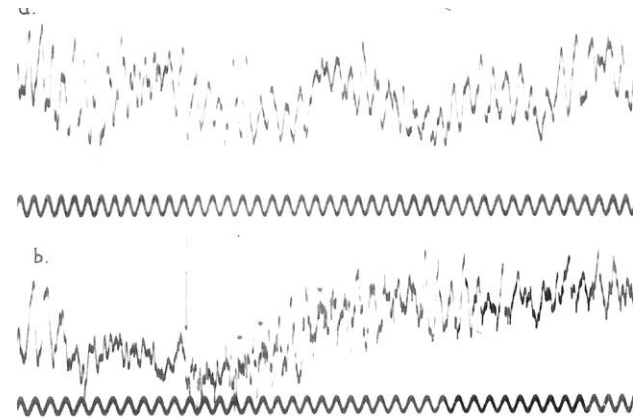

EEG trace measured by H Berger

1960s: using averaging of EEG traces

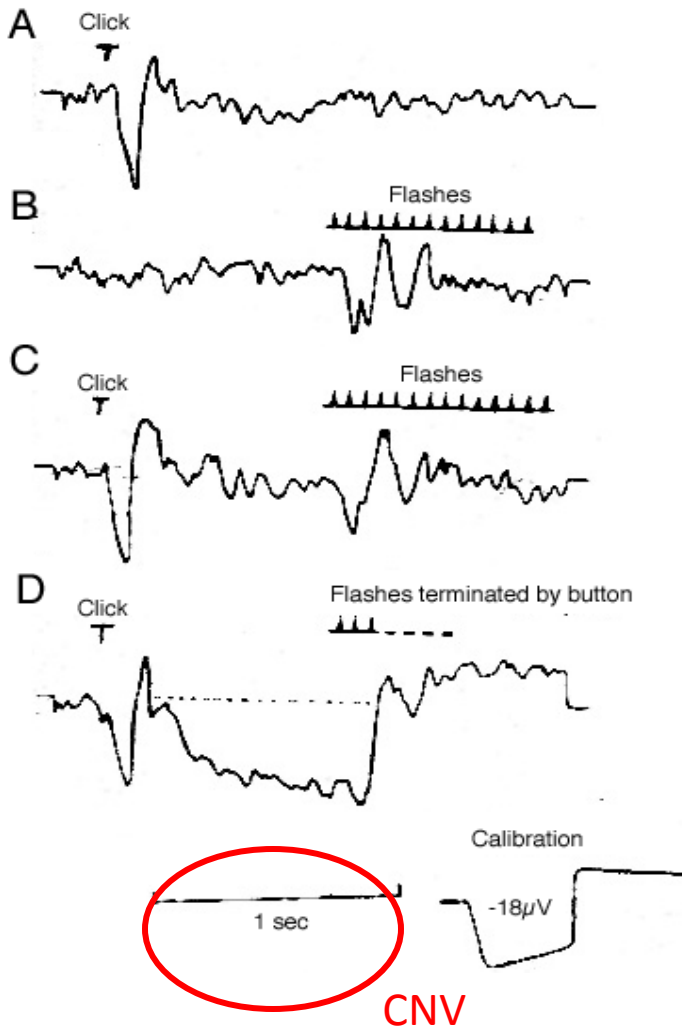

No Task: Click Only

No Task: Flashes Only

No Task: Click followed by flashes

Task: Press button when flashes start

Walter, W. G., Cooper, R., Aldridge, V. J., McCallum, W. C., & Winter, A. L. (1964). **Contingent negative variation**: An electric sign of sensorimotor association and expectancy in the human brain. *Nature*, 203, 380-384.

Slide adapted from SJ Luck

MEG: early days

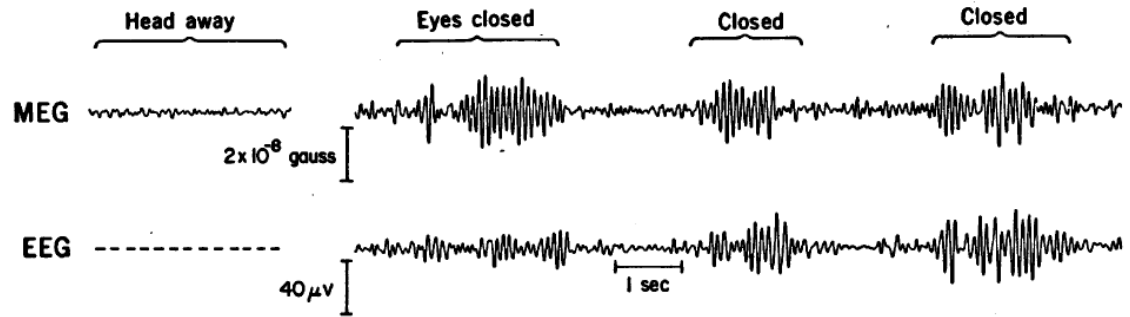
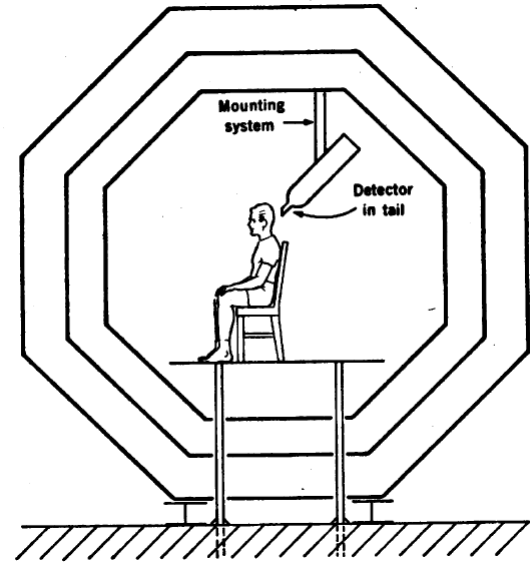

Cohen (*Science*, 1972) describes the first 1-sensor MEG recording with the so-called SQUID technique (see below).

MEG: Requires ultrasensitivity

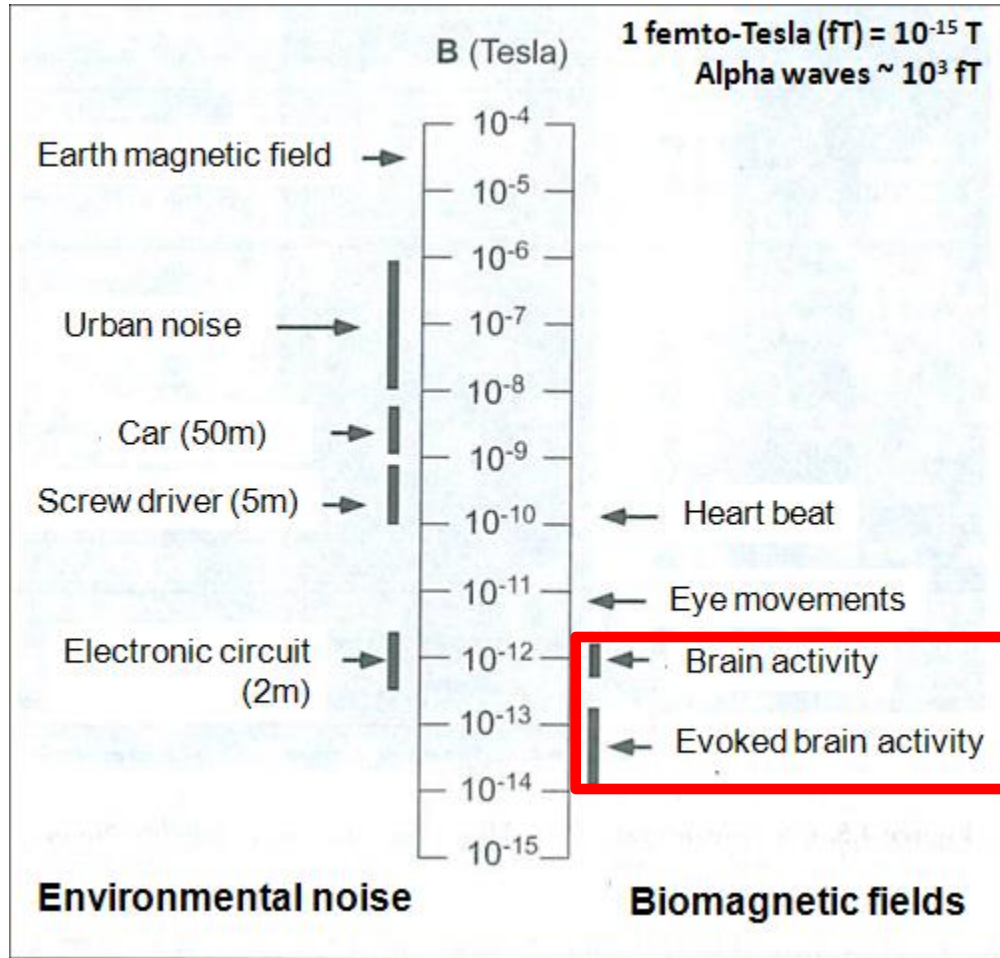
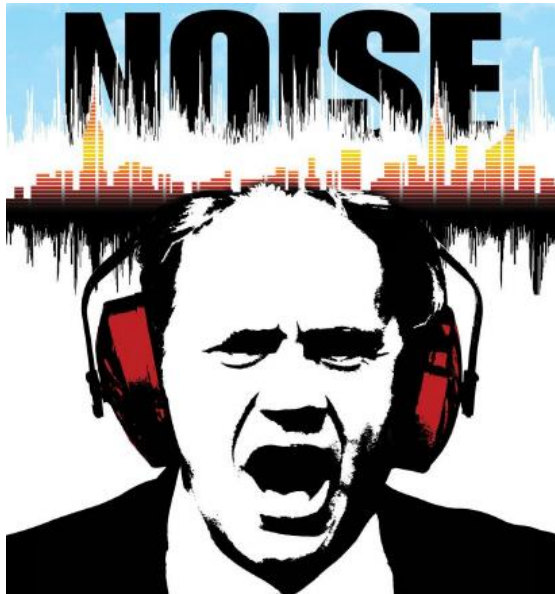

SQUIDs

1970: James Zimmerman (Ford Co., USA) invents the **Superconducting Quantum Interference Device (SQUID)**, an ultrasensitive detector of magnetic flux.

Superconductivity is zero-resistance electrical conduction that (typically) occurs at extremely cold temperatures, near absolute zero.

The SQUID is in essence a magnetic flux-to-voltage converter.

SQUIDs in MEG require temperature at -269 degrees Celsius, achieved by using liquid helium.

1973: Brian Josephson (Cambridge, UK) awarded the Nobel prize for prediction (in **1962**) of 'tunnel effect' between two superconducting materials separated by a thin insulating layer ('Josephson Junction')

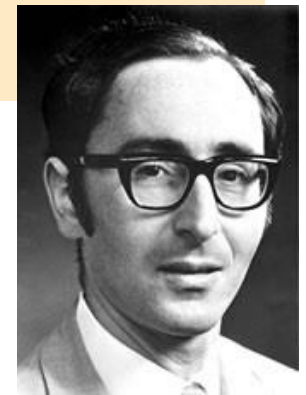
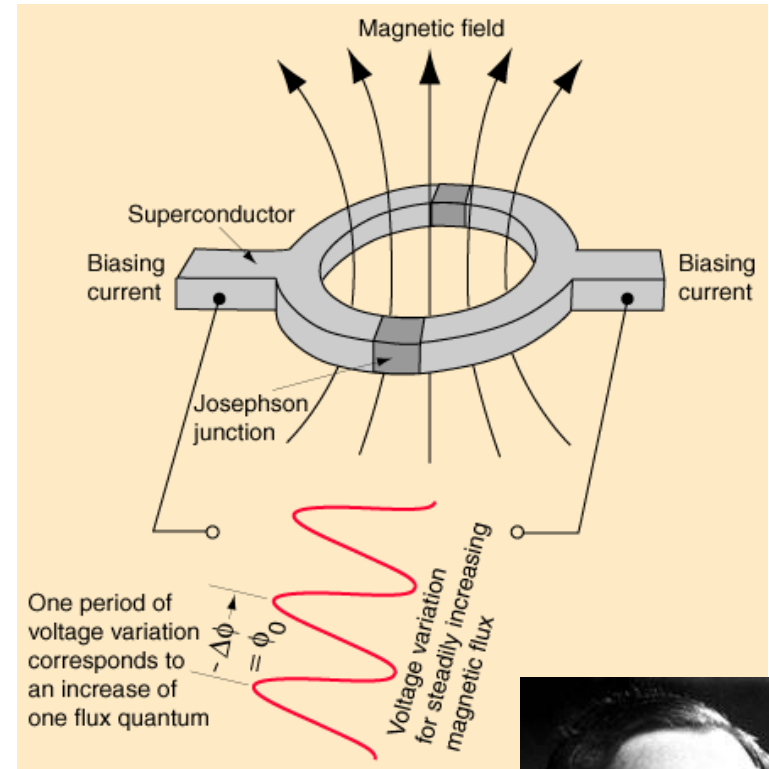

Brian Josephson

Overview

1 History

2 Genesis of M/EEG signal

3 Measurement specifics

4 Forward models

Current along pyramidal cell

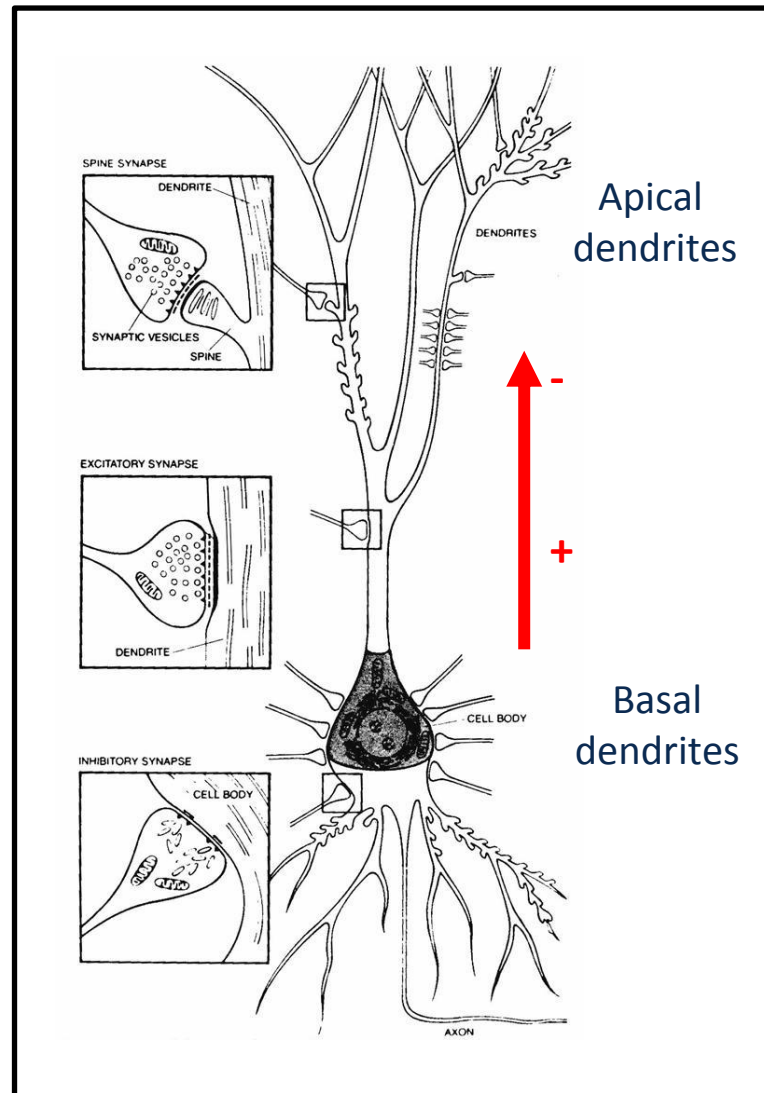
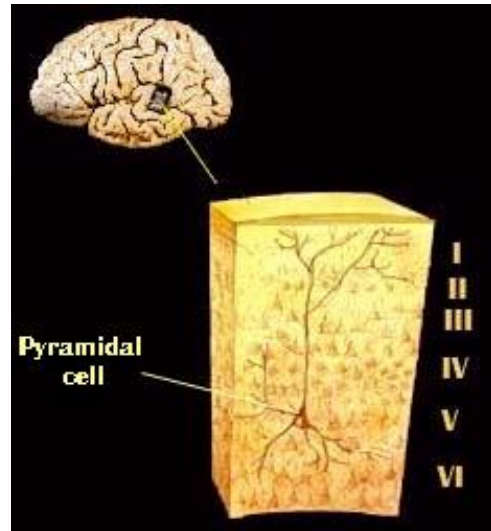

The largest contribution to MEG/EEG is caused by **postsynaptic potentials (PSPs)** in pyramidal cells.

When an excitatory PSP (EPSP) provides input to a pyramidal cell, positively charged ions are transported into the cell.

This causes a so-called sink and generates a potential difference along the membrane between the apical dendrites and and soma.

Measurement of indirect effects of current

Estimate: ~1 million synapses must be simultaneously active to be detected

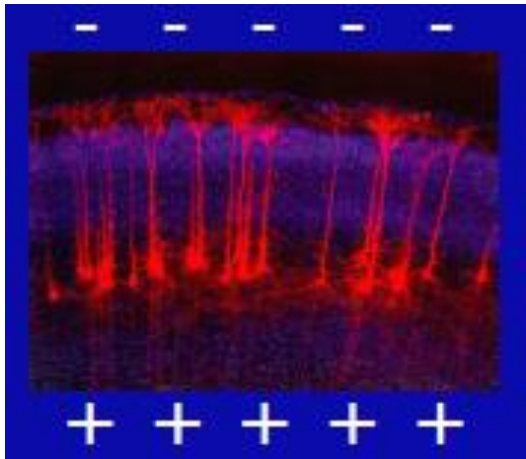

Fortunately, there are ~10 million cells per mm^2 with 1000s of synapses each.

Along with the **primary current**, **volume currents** are induced in the surrounding tissues.

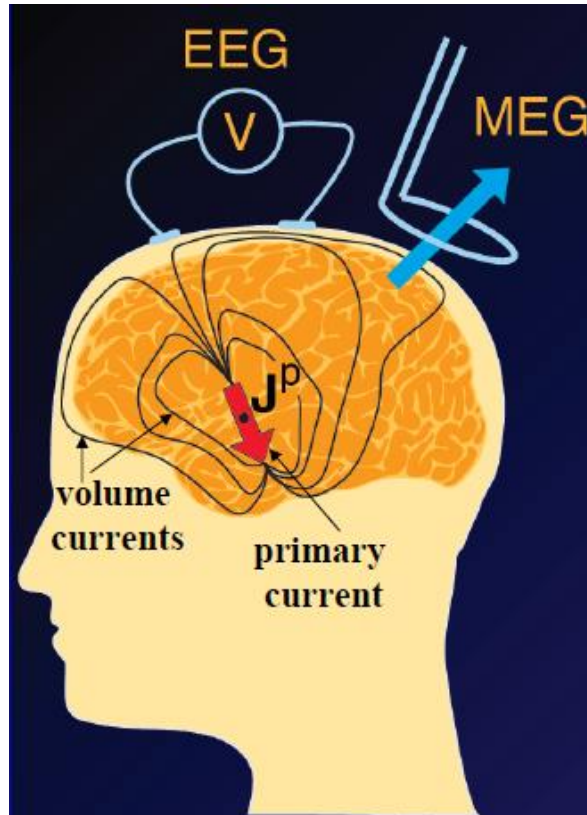

The fields caused by the primary current can be approximated by a so-called dipole.

The electrical field is measured by electrodes on the scalp, giving rise to the EEG.

The MEG measures the magnetic flux caused by the primary current.

EEG: Volume conduction

When a dipole is in a conductive medium, electrical current spreads through this medium (the 'volume' or 'secondary' currents). They reach the scalp to induce the voltage differences that EEG is sensitive to.

Brain, skull and scalp have different conductivities.

The skull has a higher electrical resistance than the brain.

=> the electrical signal spreads laterally when reaching the skull.

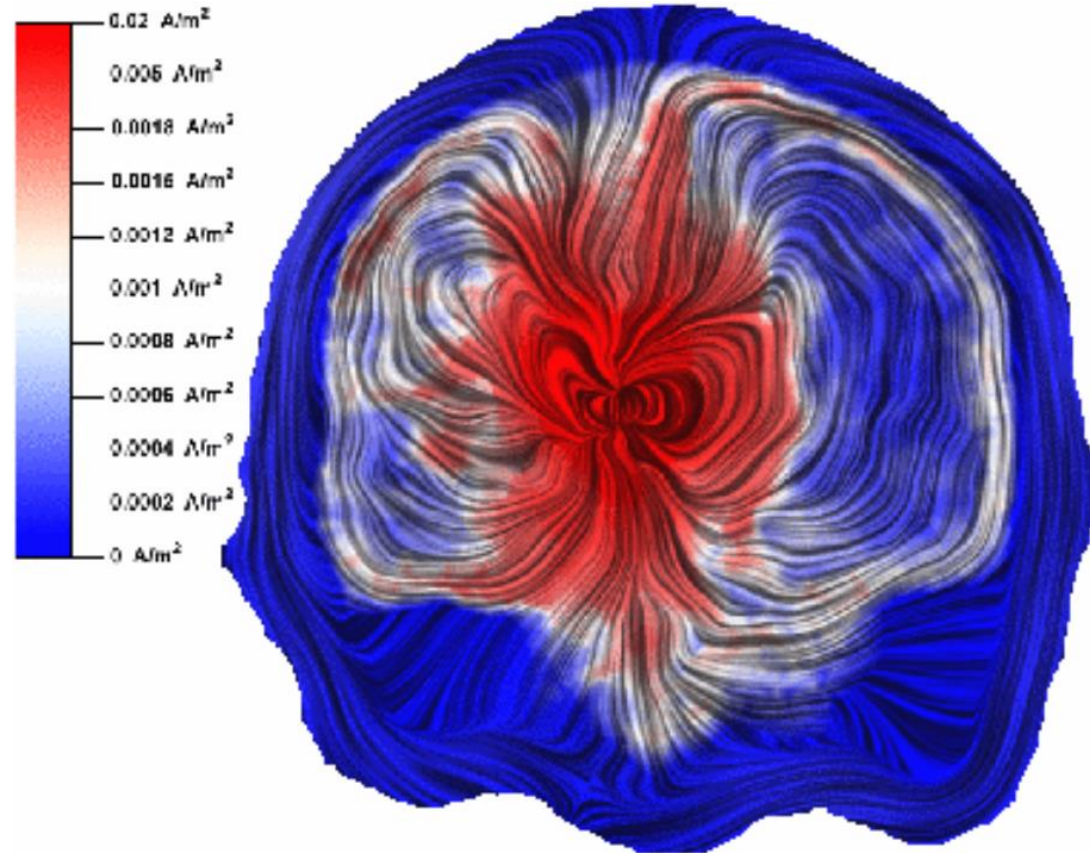

Volume currents for a thalamic dipole source computed using a so-called finite element volume conductor model. (scholarpedia, C Wolters)

Signal depends on neuronal geometry

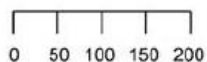
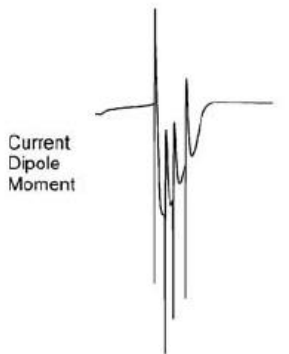
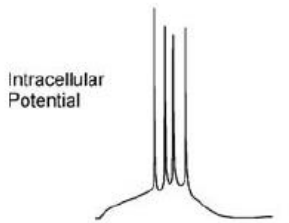

Much of the standard textbook knowledge is based on assumptions, qualitative experimental evidence, or (presumably too) simple models.

Recent studies stress that it is important to take into account the detailed morphology of neurons to predict expected dipole strengths for M/EEG.

Idea: Simulate intracellular current using detailed dendritic anatomy of neurons.

Such studies show that 50,000 pyramidal cells may generate a (measurable) dipolar source of 10 nAm.

Spikes? Modelling study suggests that highly synchronized spikes from $\sim 10,000$ pyramidal cells may produce a measurable signal (contrary to standard assumptions).

Murakami & Okada, 2006

Source orientation

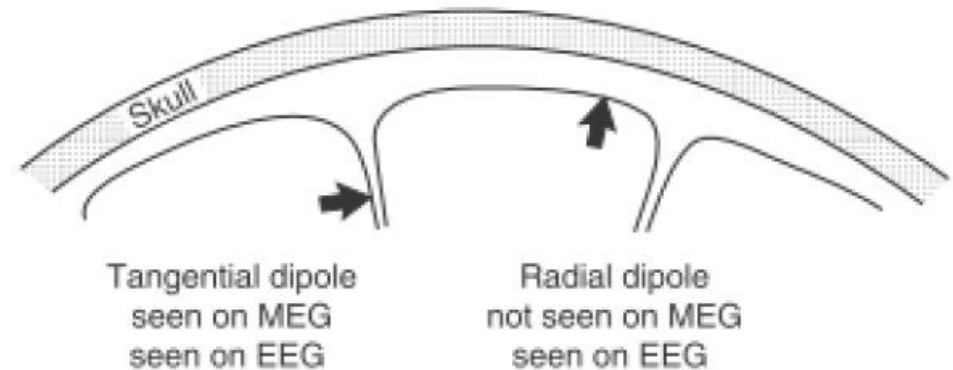
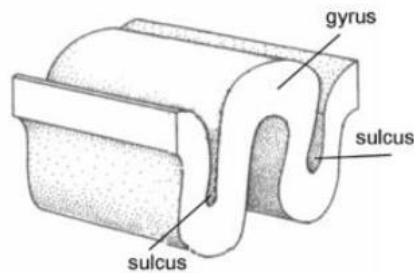

The orientation of the pyramidal cells depends on the cortical folding pattern.

MEG less sensitive to radial dipoles; EEG sensitive to both.

Many textbooks state that MEG is 'blind' to radial dipoles. This only holds under the assumptions (i) of a spherically symmetric volume conductor and (ii) that the source is a single radially oriented dipole.

Source orientation: synthetic data

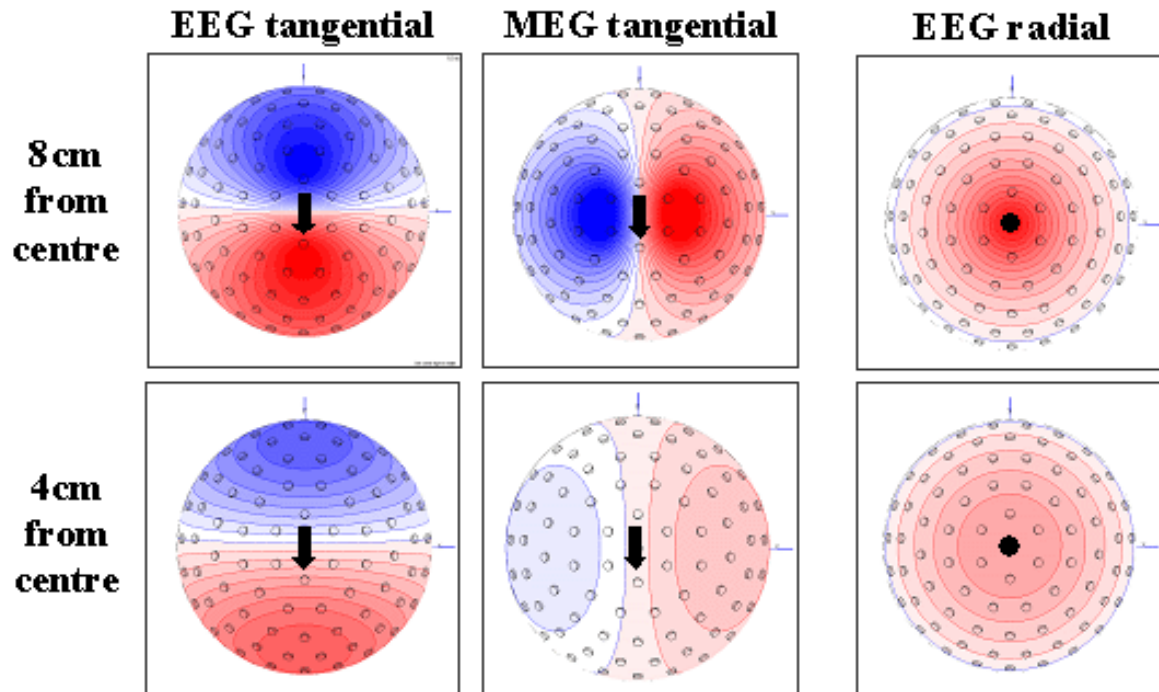

Negative
Positive

MEG radial not shown (no signal with these synthetic data).

From <http://imaging.mrc-cbu.cam.ac.uk>

MEG: Right hand rule

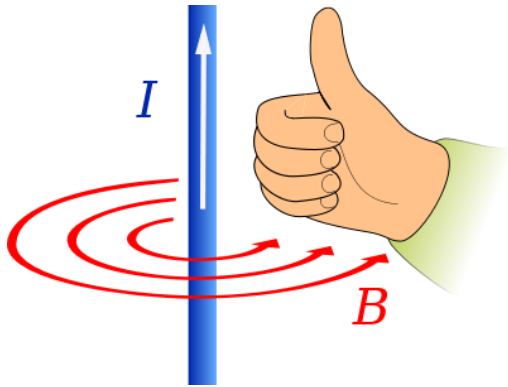

Right hand rule can be used to predict the direction of the magnetic field B caused by the electric current I .

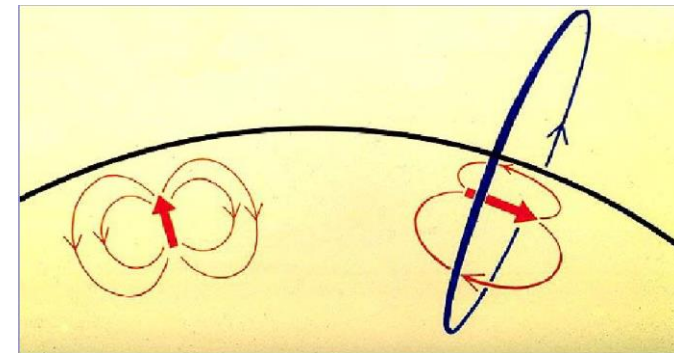
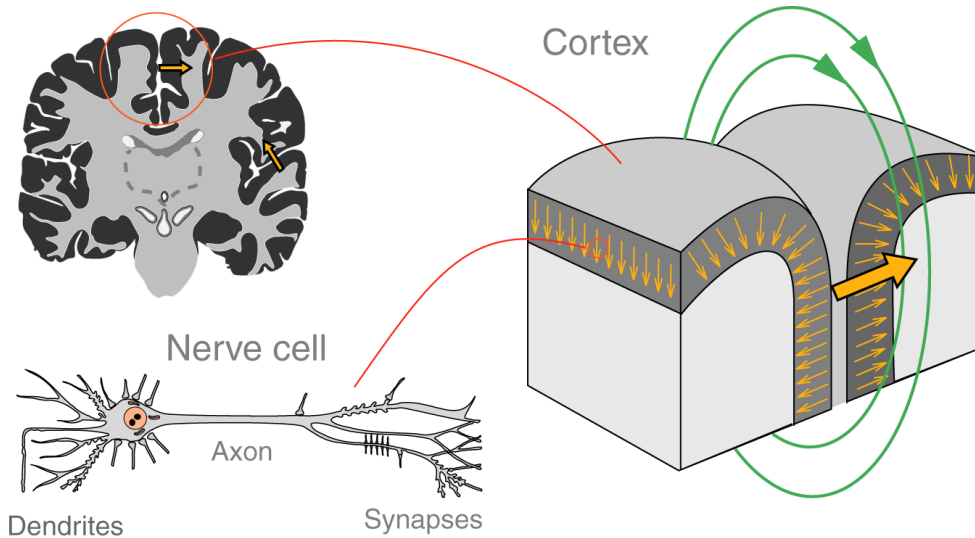
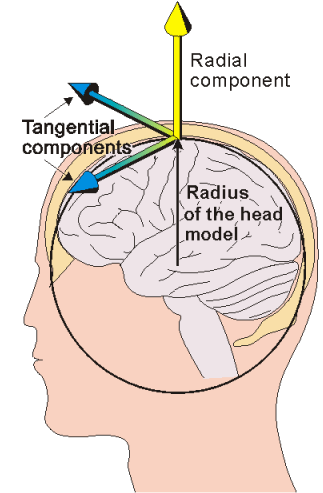

Overview

1 History

2 Genesis of M/EEG signal

3 Measurement specifics

4 Forward models

EEG measurements

Continuous EEG

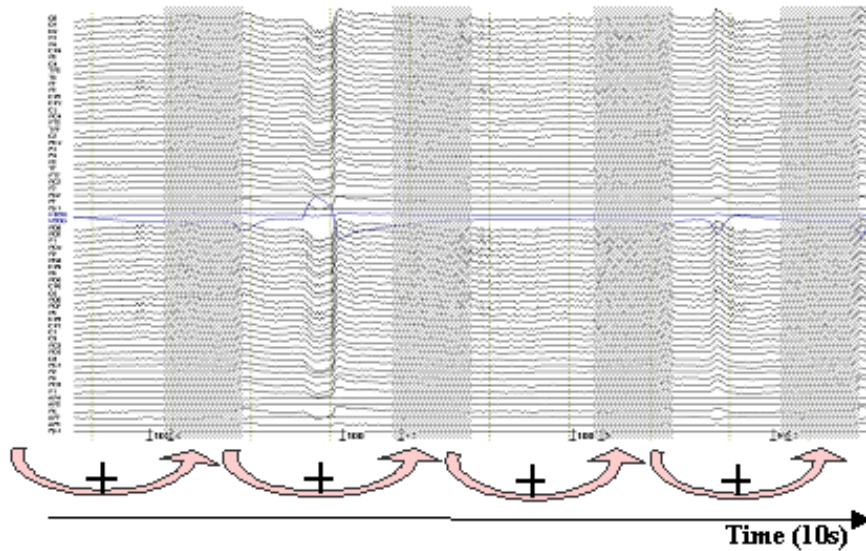

Averaged EEG

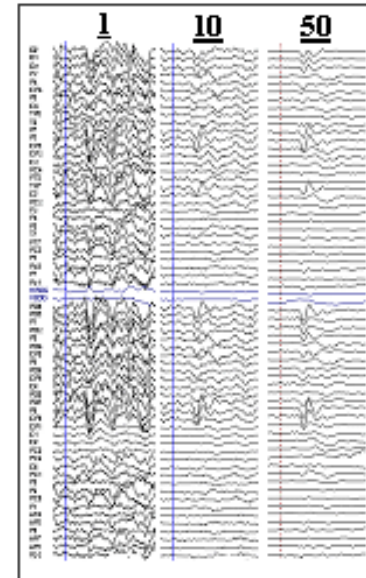

Time plot of ERP

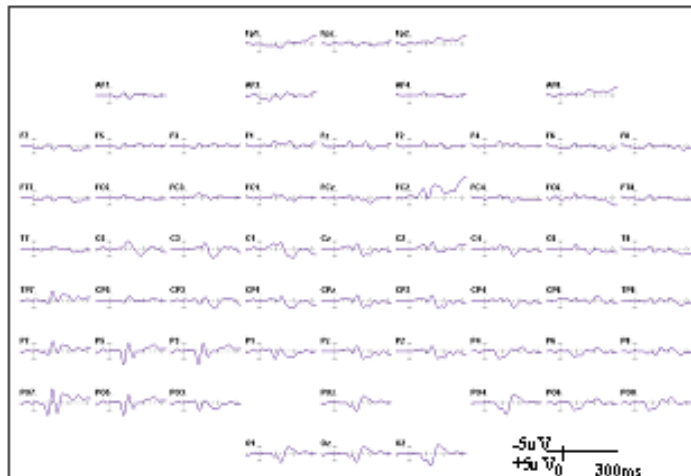

Topography of ERP at 90ms

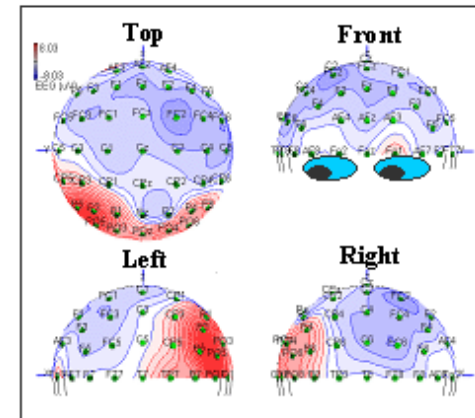

From <http://imaging.mrc-cbu.cam.ac.uk>

MEG: Instrumentation

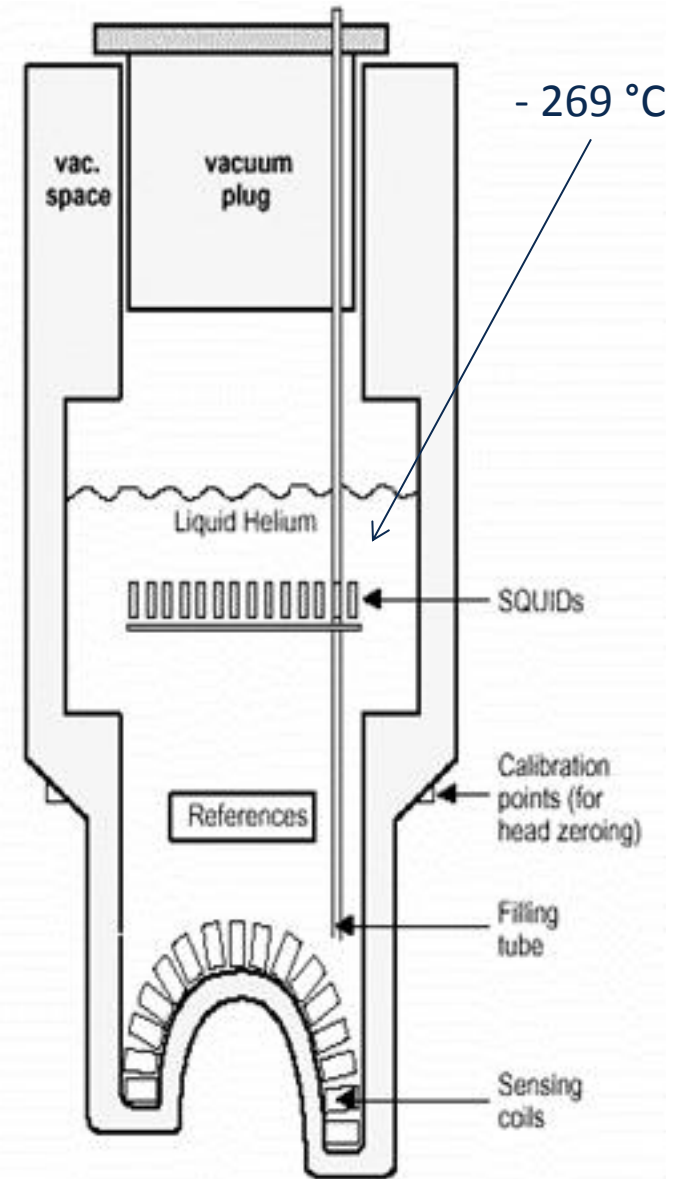
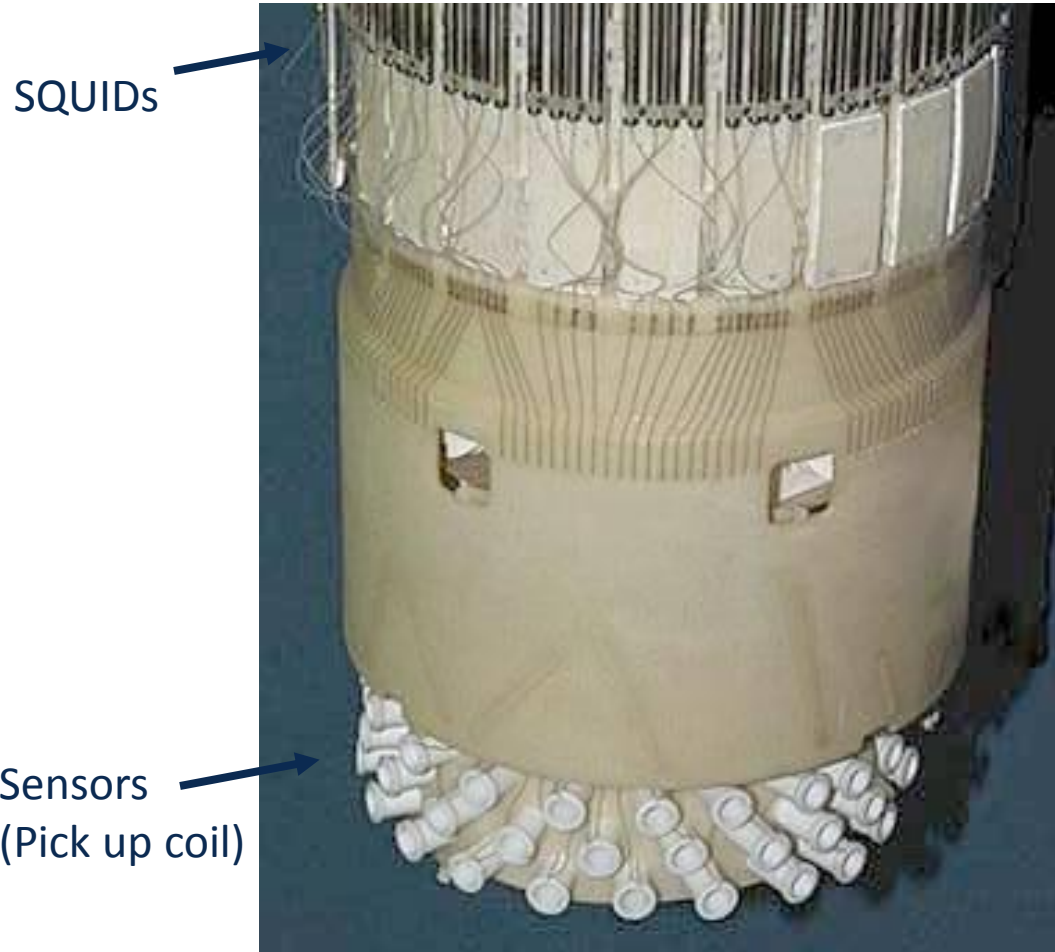

MEG: Measurement coils

Modern MEGs use two different types of coils:

Magnetometers

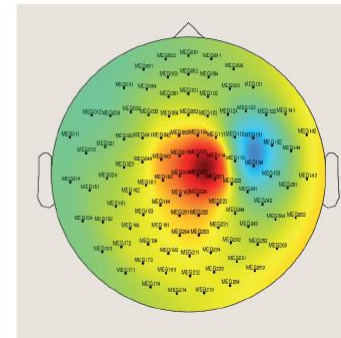
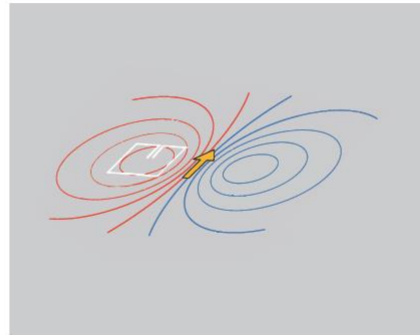
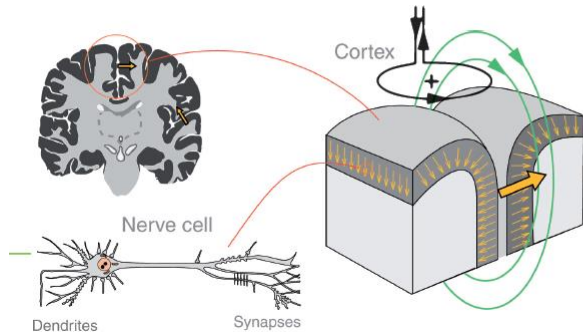

Measures the magnetic flux

Gradiometers

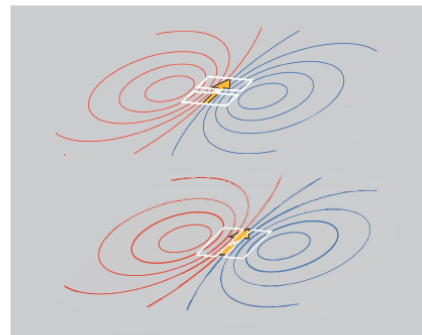
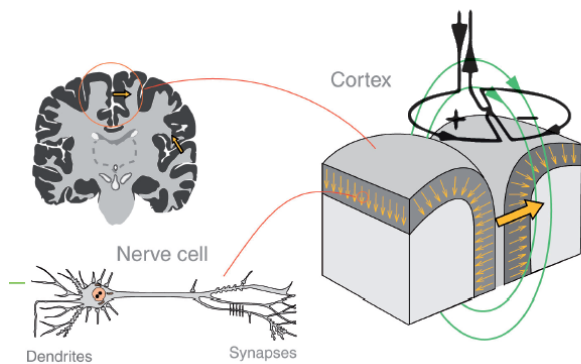

Two spatial directions

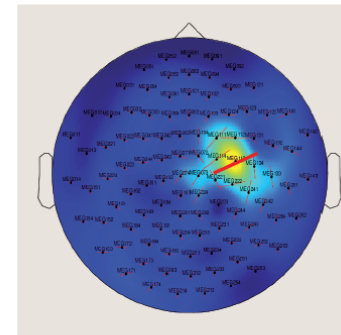

Red line indicates direction of change

Measures the spatial gradient (i.e. change) of magnetic flux.

MEG: Elekta Neuromag Vector View System

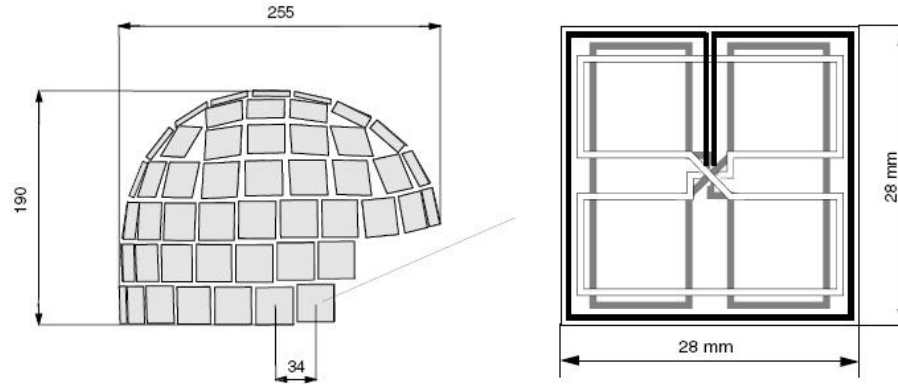

Sensor Array
 102 magnetometers
 204 planar gradiometers



M/EEG measurement

+ EEG Cap

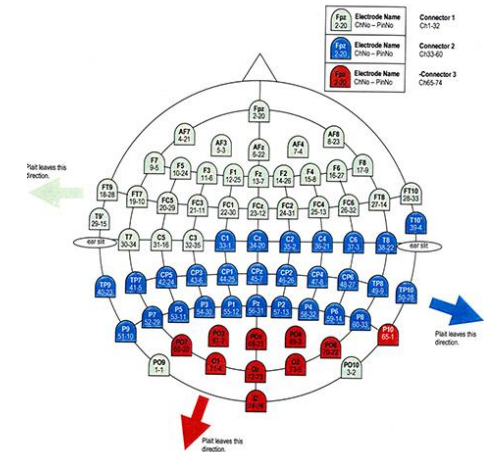

Slide 21/30

EEG: 10-20 system

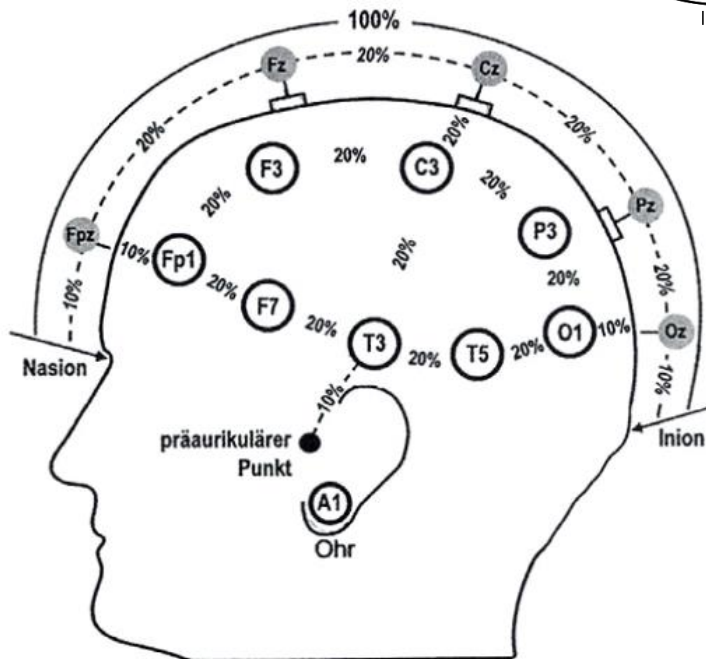
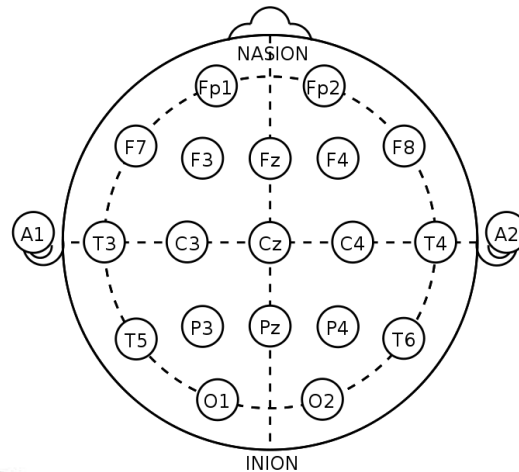

The international 10-20 system defines electrode positions by using individual landmarks and was described in 1958 by Jasper.

Its aim was to standardize electrode locations and labelling to enable comparisons across studies.

It is highly practical and still used, e.g. in clinical setups, but EEG measurements in research usually use ~64+ electrodes using caps.

An alternative way to achieve comparability across studies is to use source reconstruction techniques to project data to brain space (see Tuesday lectures).

EEG: Caps



Biosemi cap with 256 electrodes



Putting on a cap

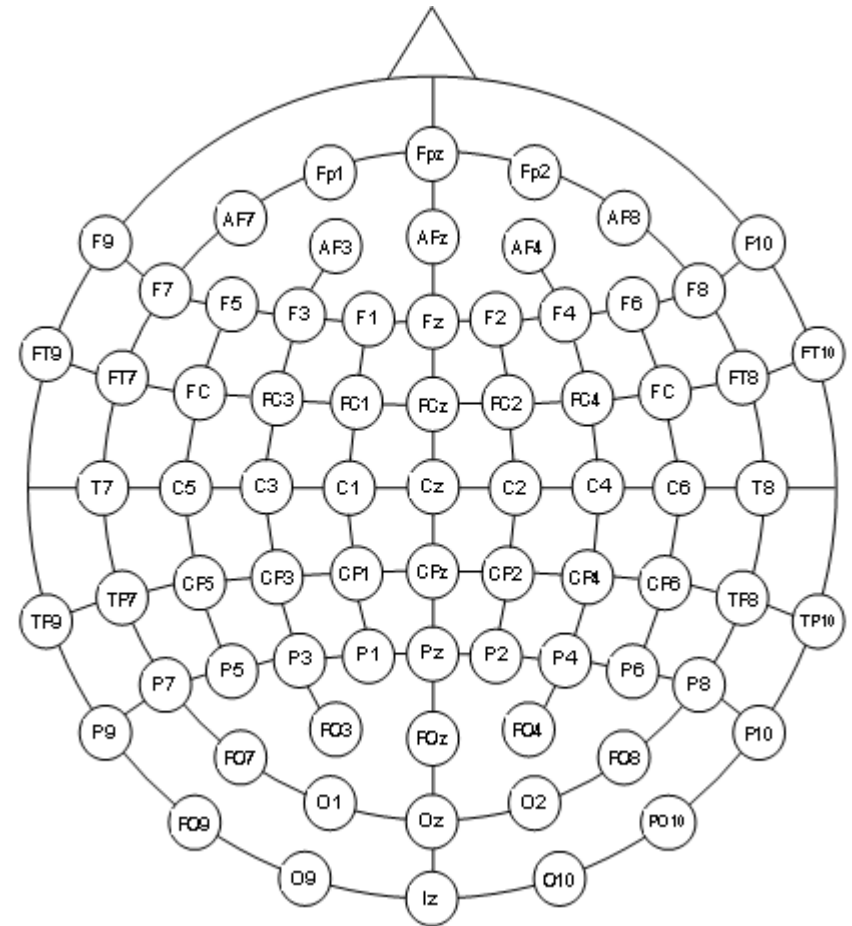

Easycap layout with 80 channels

EEG: Reference electrode

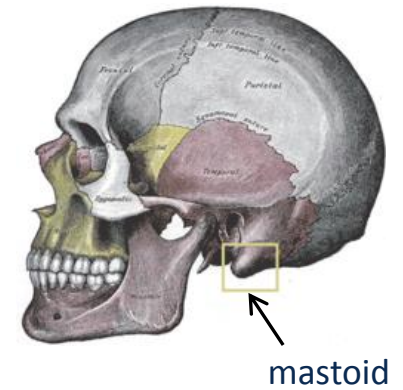

EEG electrodes measure potential differences relative to a reference (REF).

Ideally, references should not show any activity relevant to cognition. For example, one position is on the bone behind the ear (mastoid).

A typical EEG measurement would use ,linked ears' which is the average of the two mastoid reference electrodes.

For recordings with > ~64 channels, one often uses an ,average reference' (the reference is the average signal of all channels). Note that with digital EEGs (commonplace today) one can re-reference after the measurement.

The ,ground' (GND) is important to eliminate potential differences between amplifier and participant.

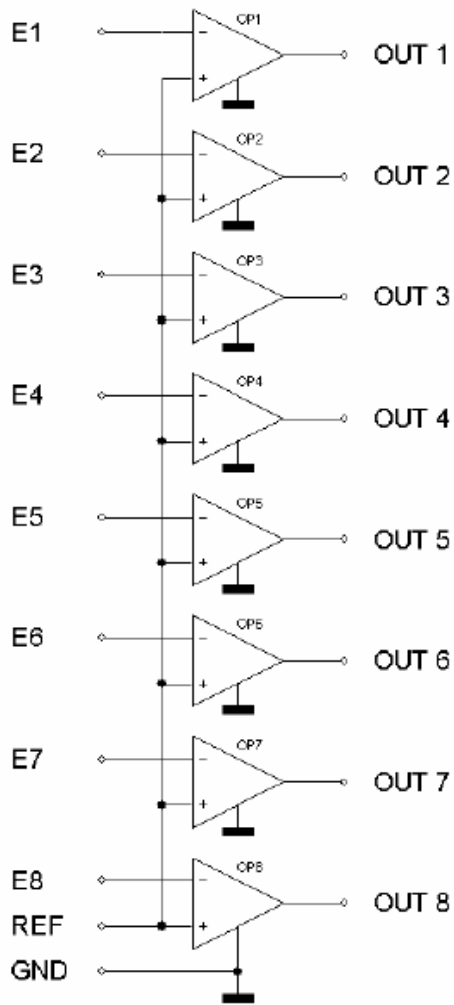

Overview

1 History

2 Genesis of EEG/MEG signal

3 Measurement specifics

4 Forward models

Lead fields

Forward problem

MEG

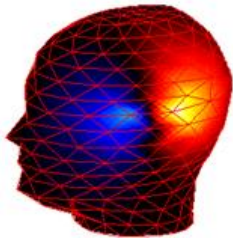

EEG

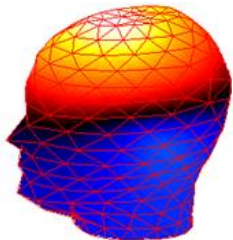

Lead fields



forward
model

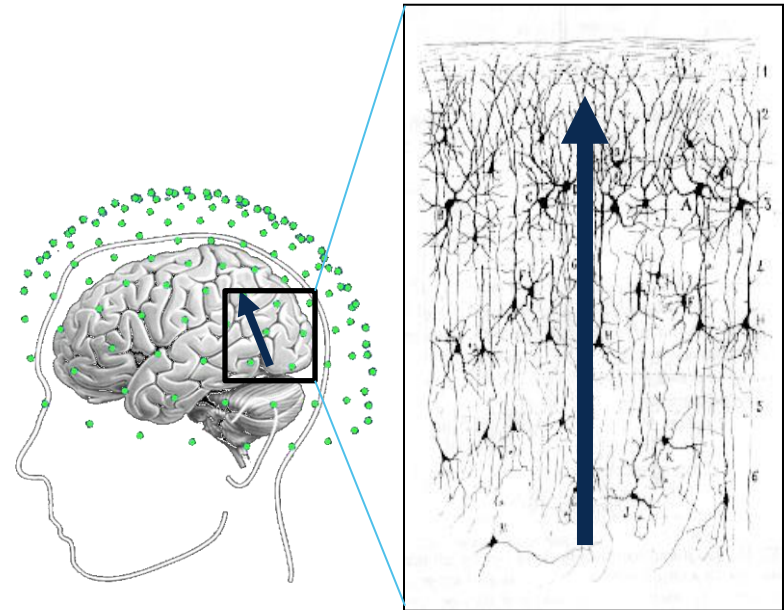

Dipolar sources

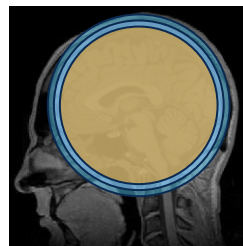

Head models

Finite Element

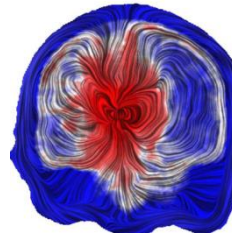

Boundary Element

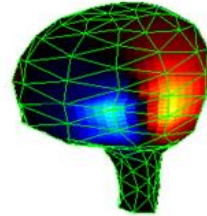

Multiple spheres

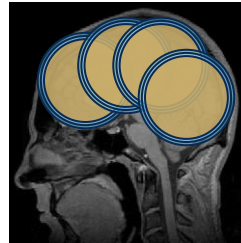

Single sphere

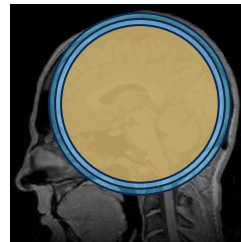

Simpler models

Inverse problem: Source reconstruction

The inverse problem (estimating source activity from sensor data) is ill-posed. So you have to add some prior assumptions

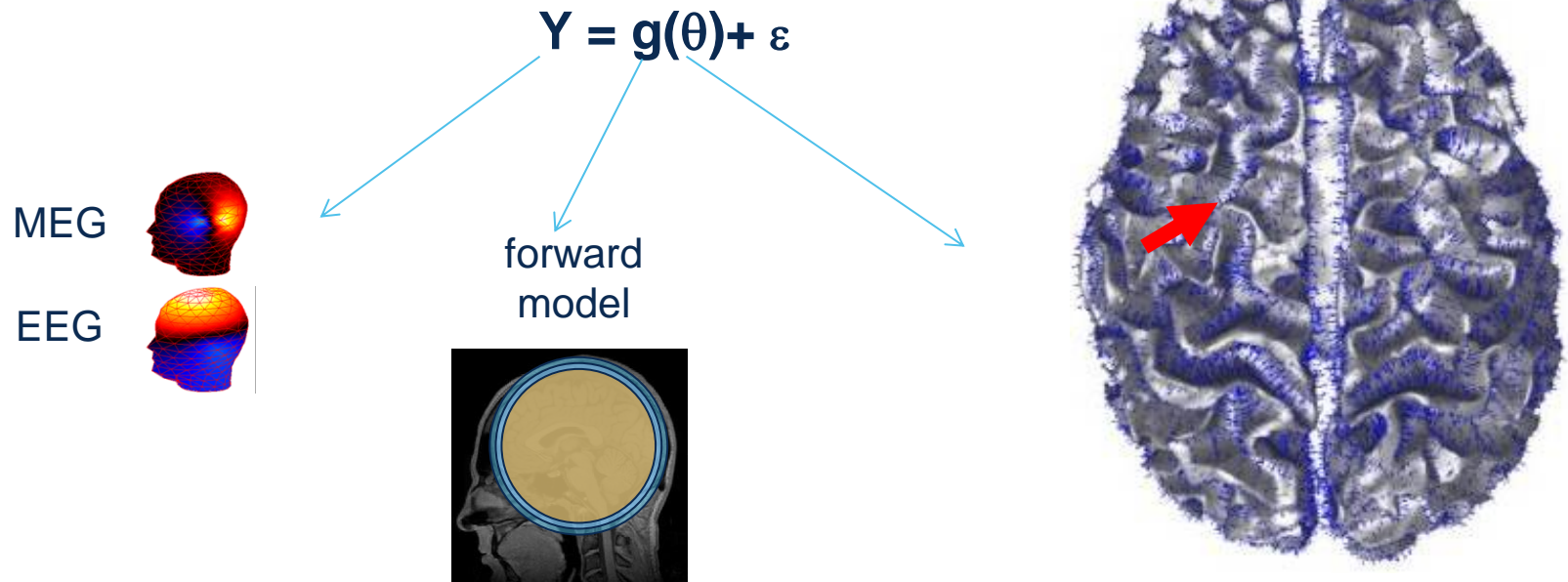

For example, can make a good guess at realistic orientation (along pyramidal cell bodies, perpendicular to cortex)

Dynamical Causal Modelling:
Use assumption about network dynamics to provide constraints.

Summary

EEG/MEG presumably caused by synchronous PSPs to 50,000+ pyramidal cells, which are arranged in parallel.

Cortical anatomy (folding) plays a big role of how the signal looks like in the sensors.

Excellent temporal resolution ($< \text{ms}$) but spatial resolution can be quite low ($\sim 1 \text{ cm}$) depending on where the signal comes from.

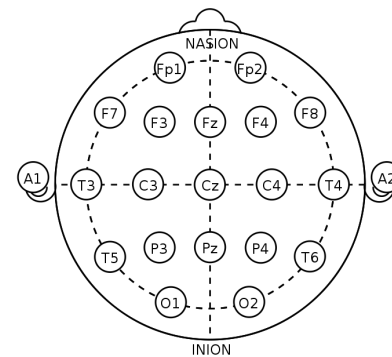
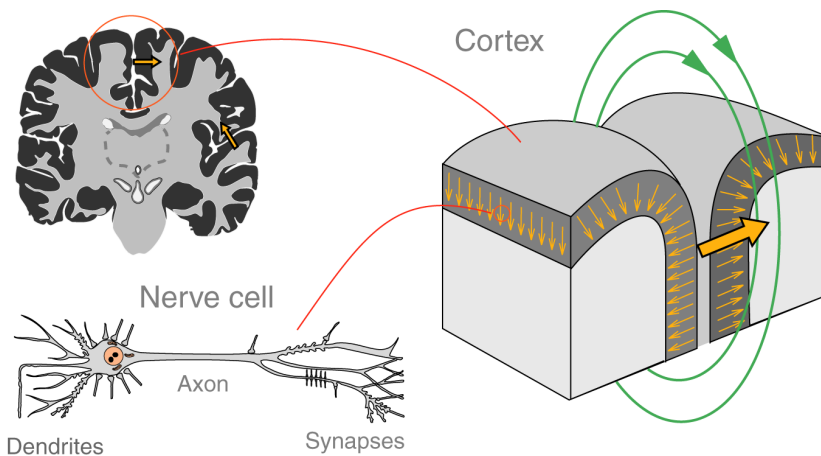

Acknowledgments

Thanks to

Dorothea Hämmerer @ Institute of Cognitive Neuroscience, UCL, London

Steven Luck @ Center for Mind and Brain, UC Davis

Saskia Helbling @ IMP, Goethe-Univ., Frankfurt

Jeremie Mattout @ Lyon Neuroscience Research Center, Lyon

Vladimir Litvak @ WTC for Neuroimaging, UCL, London

FIL methods group @ WTC for Neuroimaging, UCL, London